

Non-isolation type low price high precision analog input board for Low Profile PCI

AD16-16(LPCI)L



* Specifications, color and design of the products are subject to change without notice.

Features

Rich set of basic functions

Compact system providing high-precision analog inputs. This product is a control signal(3 points) of analog input(16bits, 16ch), analog input. Digital inputs (four channels), digital outputs (four channels), and a counter (32-bit one channel).

Substantial control functions

Capable of analog input in time-based mode or external-signal synchronous mode.

Filter function facilitating external signal connection

Digital filters provided for external control analog input signals, preventing chattering

Buffer memory

The analog inputs have own buffer memory. You can also perform analog input in the background, independent of software and the current status of the PC.

Software-based calibration function

Calibration of analog input can be all performed by software. Apart from the adjustment information prepared before shipment, additional adjustment information can be stored according to the use environment.

Exchangeable low-profile and standard PCI slots

Support for both of low-profile and standard PCI slots (interchangeable with a bundled bracket).

Supported to the data logger software [C-LOGGER]

Supporting the data logger software [C-LOGGER] that enables the graph display of recorded signal data, file saving, and dynamic transfer to the spreadsheet software program "Excel"

Plug-ins for the dedicated libraries, the board also supports MATLAB and LabVIEW.

We offer a dedicated library [ML-DAQ], which allows you to use this product on MATLAB by The MathWorks as well as another dedicated library [VI-DAQ], which allows you to use the product on LabVIEW.

These dedicated libraries are available, free of charge (downloadable), on our web site.

This product is a PCI-compliant interface board that incorporates high-precision analog inputs, digital inputs, digital outputs, and a counter function.

The board can make your space-saving PC into a cost-effective analog input system.

You can use the driver library (API-PAC(W32)) supplied with the board to write Windows application programs in any programming language (such as Visual Basic, Visual C++, etc.) that supports the calling of Win32 API functions.

It can also collect data easily without a program when the data logger software [C-LOGGER] stored on the attached CD-ROM is used. With plug-ins for the dedicated libraries, the board also supports MATLAB and LabVIEW.

Specification

Item	Specification
Analog input	
Isolated specification	Unisolated
Input type	Single-Ended Input
Number of input channels	16ch
Input range	Bipolar $\pm 10V$
Absolute max. input voltage	$\pm 20V$
Input impedance	1M Ω or more
Resolution	16bit
Non-Linearity error *1*2	$\pm 5LSB$
Conversion speed	10 $\mu sec/ch$
Buffer memory	1k Word
Conversion start trigger	Software / external trigger
Conversion stop trigger	Number of sampling times / external trigger/software
External start signal	TTL level (Rising or falling edge can be selected by software) Digital filter (1 μsec can be selected by software)
External stop signal	TTL level (Rising or falling edge can be selected by software) Digital filter (1 μsec can be selected by software)
External clock signal	TTL level (Rising or falling edge can be selected by software)
Digital I/O	
Number of input channels	Unisolated input 4ch (TTL level positive logic)
Number of output channels	Unisolated output 4ch (TTL level positive logic)
Counter	
Number of channels	1ch
Counting system	Up count
Max. count	FFFFFFFFh (Binary data,32bit)
Number of external inputs	2 TTL level (Gate/Up)/ch Gate (High level), Up (Rising edge)
Number of external outputs	TTL level Count match output (positive logic, pulse output)
Response frequency	10MHz (Max.)
Common section	
I/O address	64 ports
Interruption level	Errors and various factors, One interrupt request line as INTA
Connector	10250-52A2JL[3M]
Power consumption	5VDC 260mA (Max.)
Operating condition	0 - 50°C, 10 - 90%RH (No condensation)
PCI bus specification	32bit, 33MHz, Universal key shapes supported *3
Dimension (mm)	121.69 (L) x 63.41 (H)
Weight	60g

*1 The non-linearity error means an error of approximately 0.1% occurs over the maximum range at 0°C and 50°C

*2 At the time of the source use of a signal which built in the high-speed operational amplifier.

*3 This board requires power supply at +5V from an expansion slot (it does not work on a machine with a +3.3V)

Board Dimensions

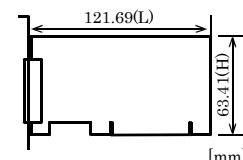

The standard outside dimension(L) is the distance from the end of the board to the outer surface of the slot cover.

Support Software

Windows version of analog I/O driver API-AIO(WDM) [Stored on the bundled CD-ROM driver library API-PAC(W32)]

The API-AIO(WDM) is the Windows version driver library software that provides products in the form of Win32 API functions (DLL). Various sample programs such as Visual Basic and Visual C++, etc and diagnostic program useful for checking operation is provided.

< Operating environment >
OS Windows Vista, XP, Server 2003, 2000
Adaptation language Visual Basic, Visual C++, Visual C#, Delphi, C++ Builder

You can download the updated version from the CONTEC's Web site (<http://www.contec.com/apipac/>). For more details on the supported OS, applicable language and new information, please visit the CONTEC's Web site.

Linux version of analog I/O driver API-AIO(LNX) [Stored on the bundled CD-ROM driver library API-PAC(W32)]

The API-AIO(LNX) is the Linux version driver software which provides device drivers (modules) by shared library and kernel version. Various sample programs of gcc are provided.

< Operating environment >
OS RedHatLinux, TurboLinux
(For details on supported distributions, refer to Help available after installation.)

Adaptation language gcc

You can download the updated version from the CONTEC's Web site (<http://www.contec.com/apipac/>). For more details on the supported OS, applicable language and new information, please visit the CONTEC's Web site.

Data Logger Software C-LOGGER [Stored on the bundled CD-ROM driver library API-PAC(W32)]

C-LOGGER is a data logger software program compatible with our analog I/O products. This program enables the graph display of recorded signal data, zoom observation, file saving, and dynamic transfer to the spreadsheet software "Excel". No troublesome programming is required.

CONTEC provides download services (at <http://www.contec.com/clogger>) to supply the updated drivers. For details, refer to the C-LOGGER Users Guide or our website.

< Operating environment >
OS Windows Vista, XP, Server 2003, 2000

Data Acquisition library for MATLAB ML-DAQ (Available for downloading (free of charge) from the CONTEC web site.)

This is the library software which allows you to use our analog I/O device products on MATLAB by the MathWorks. Each function is offered in accordance with the interface which is integrated in MATLAB's Data Acquisition Toolbox. See <http://www.contec.com/mldaq/> for details and download of ML-DAQ.

Data acquisition VI library for LabVIEW VI-DAQ (Available for downloading (free of charge) from the CONTEC web site.)

This is a VI library to use in National Instruments LabVIEW. VI-DAQ is created with a function form similar to that of LabVIEW's Data Acquisition VI, allowing you to use various devices without complicated settings. See <http://www.contec.com/vidaq/> for details and download of VI-DAQ.

Cable & Connector

Cable (Option)

Shield Cable with 50-Pin Mini-Ribbon Connectors
at either Ends : PCB50PS-0.5P (0.5m)
: PCB50PS-1.5P (1.5m)

Shield Cable with 50-Pin Mini-Ribbon Connector
at one End : PCA50PS-0.5P (0.5m)
: PCA50PS-1.5P (1.5m)

Accessories

Accessories (Option)

Screw Terminal Unit (M3 x 50P) : EPD-50A *1 *6
Buffer Amplifier Box
for Analog Input Boards (8ch type) : ATBA-8L *1*3*4
Buffer Amplifier Box
for Analog Input Boards (16ch type) : ATBA-16L *1*3
BNC Terminal Unit (for analog input 8ch): ATP-8L *1*5

*1 PCB50PS-0.5P or PCB50PS-1.5P optional cable is required separately.
*3 An external power supply is necessary (optional AC adaptor POA200-20 prepared.)
*4 Capable of using the analog input of up to 8ch.
*5 Capable of using the analog input of up to 8ch, and analog output of up to 2ch.
*6 "Spring-up" type terminal is used to prevent terminal screws from falling off.

* Check the CONTEC's Web site for more information on these options.

Packing List

Board [AD16-16(LPCI)L] ...1
First step guide ... 1
CD-ROM *1 [API-PAC(W32)] ...1
Standard size bracket ...1

*1 The CD-ROM contains the driver software and User's Guide.

Block Diagram

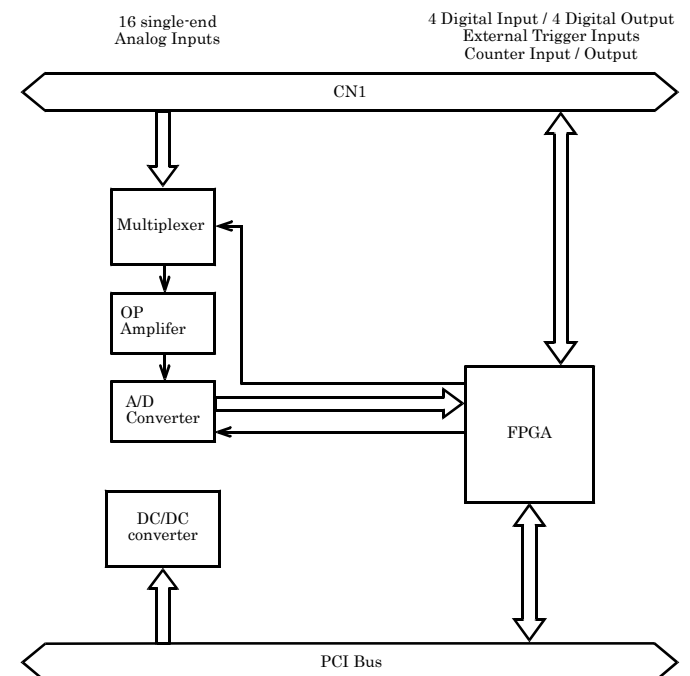

How to connect the connectors

Connector shape

To connect an external device to this board, plug the cable from the device into the interface connector (CN1) shown below.

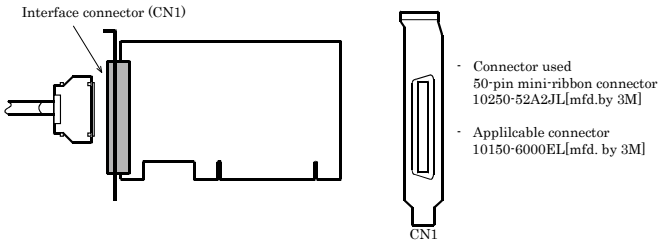

* Please refer to page 2 for more information on the supported cable and accessories.

Connector Pin Assignment

Pin Assignments of Interface Connector (CN1)

Non Connect	N.C.	50	25	-N.C.	Non Connect
Non Connect	N.C.	49	24	-N.C.	Non Connect
Non Connect	N.C.	48	23	-N.C.	Non Connect
Non Connect	N.C.	47	22	-N.C.	Non Connect
Analog Input 04	AI 04	46	21	-AI 00	Analog Input 00
Analog Input 12	AI 12	45	20	-AI 08	Analog Input 08
Analog Input 05	AI 05	44	19	-AI 01	Analog Input 01
Analog Input 13	AI 13	43	18	-AI 09	Analog Input 09
Analog Ground (for AI)	AGND	42	17	-AGND	Analog Ground (for AI)
Analog Ground (for AI)	AGND	41	16	-AGND	Analog Ground (for AI)
Analog Input 06	AI 06	40	15	-AI 02	Analog Input 02
Analog Input 14	AI 14	39	14	-AI 10	Analog Input 10
Analog Input 07	AI 07	38	13	-AI 03	Analog Input 03
Analog Input 15	AI 15	37	12	-AI 11	Analog Input 11
Non Connect	N.C.	36	11	-AI START	AI External Start Trigger Input
Non Connect	N.C.	35	10	-AI STOP	AI External Stop Trigger Input
Non Connect	N.C.	34	9	-AI EXCLK	AI External Sampling Clock Input
Digital Ground	DGND	33	8	-DGND	Digital Ground
Digital Output 00	DO 00	32	7	-DI 00	Digital Input 00
Digital Output 01	DO 01	31	6	-DI 01	Digital Input 01
Digital Output 02	DO 02	30	5	-DI 02	Digital Input 02
Digital Output 03	DO 03	29	4	-DI 03	Digital Input 03
Digital Ground	DGND	28	3	-DGND	Digital Ground
Counter UP Clock Input	CNT UPCLK	27	2	-CNT GATE	Counter Gate Control Input
Reserved	Reserved	26	1	-CNT OUT	Counter Output

Analog Input Signal Connection

Analog signal input types are divided into single-ended input and differential input. This board uses single-ended input fixed. The following examples show how to connect analog input signals using a flat cable and a shielded cable.

Single-ended Input

The following figure shows an example of flat cable connection. Connect separate signal and ground wires for each analog input channel on CN1.

Single-ended Input Connection (Flat Cable)

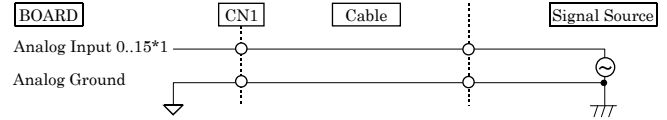

The following figure shows an example of shield cable connection. Use shielded cable if the distance between the signal source and board is long or if you want to provide better protection from noise. For each analog input channel on CN1, connect the core wire to the signal line and connect the shielding to ground.

Single-ended Input Connection (Shield Cable)

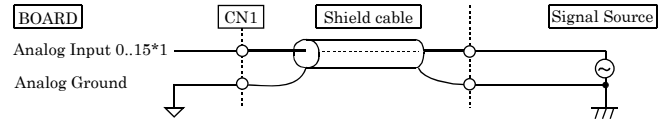

* The number of channels depends on each board. This product has 16 channels.

CAUTION

If the signal source contains over 1MHz signals, the signal may effect the cross-talk noise between channels.

If the board and the signal source receive noise or the distance between the board and the signal source is too long, data may not be input properly.

An input analog signal should not exceed the maximum input voltage (relate to the board analog ground). If it exceeds the maximum voltage, the board may be damaged.

Connect all the unused analog input channels to analog ground.

The signal connected to an input pin may fluctuate after switching of the multiplexer. If this occurs, shorten the cable between the signal source and the analog input pin or insert a high-speed amplifier as a buffer between the two to reduce the fluctuation.

An input pin may fail to obtain input data normally when the signal source connected to the pin has high impedance. If this is the case, change the signal source to one with lower output impedance or insert a high-speed amplifier buffer between the signal source and the analog input pin to reduce the effect.

Analog Input00 - Analog Input15	Analog input signal. The numbers correspond to channel numbers.
Analog Ground	Common analog ground for analog I/O signals.
AI External Start Trigger Input	External trigger input for starting analog input sampling.
AI External Stop Trigger Input	External trigger input for stopping analog input sampling.
AI External Sampling Clock Input	External sampling clock input for analog input.
Digital Input00 - Digital Input03	Digital input signal.
Digital Output00 - Digital Output03	Digital output signal.
Counter Gate Control Input	Gate control input signal for counter.
Counter Up Clock Input	Count-up clock input signal for counter.
Counter Output	Counter output signal.
Digital Ground	Common digital ground for digital I/O signals, external trigger inputs, external sampling clock inputs, and counter I/O signals.
Reserved	Reserved pin,
N.C.	No connection to this pin.

CAUTION

Do not connect any of the outputs and power outputs to the analog or digital ground.

Neither connect outputs to each other. Doing either can result in a fault.

If analog and digital ground are shorted together, noise on the digital signals may affect the analog signals. Accordingly, analog and digital ground should be separated.

Leave "Reserved" pins unconnected. Connecting these pins may cause a fault in the board.

Digital I/O signals, Counter signals and Control signals Connection

The following sections show examples of how to connect digital I/O signals, counter I/O signals, and other control I/O signals (external trigger input signals, sampling clock input signals, etc.).

All the digital I/O signals and control signals are TTL level signals.

Digital Input Connection

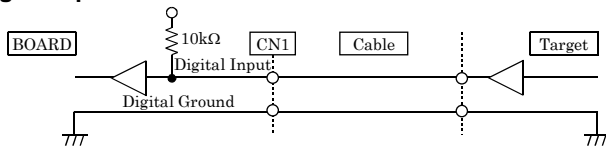

Digital Output Connection

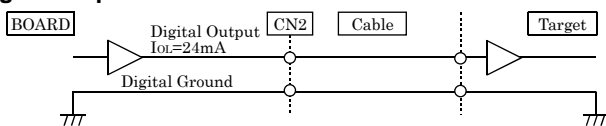

About the counter input control signal

Counter Gate Control Input (refer to the page 3 Connector Pin Assignment) acts as an input that validate or invalidate the input of an external clock for the counter. This function enables the control of an external clock input for the counter. The external clock for the counter is effective when input is "High", and invalid when input is "Low". If unconnected, it is a pull-up in the board (card) and remains "High". Therefore the external clock for the counter is effective when the counter gate control input is not connected.

⚠ CAUTION

Do not short the output signals to analog ground, digital ground, and/or power line. Doing so may damage the board.